

# Modular Lightweight Load Carrying Equipment MOLLE



## Care and Use Manual

### Fielded by

The United States Marine Corps Systems Command  
and

United States Army Soldier, Biological, Chemical Command

### Manufactured by

Specialty Defense Systems

A Division of Specialty Plastic Products

*[www.specialtydefense.com](http://www.specialtydefense.com)*



# Contents

	page
<b>1. Introduction</b>	<b>1</b>
<b>2. The MOLLE System</b>	<b>1</b>
Includes:	
Purpose of each component	
Assembly of System	
Loading & Proper Fitting	
<b>3. Donning and Doffing</b>	<b>30</b>
<b>4. Cleaning and Maintenance</b>	<b>32</b>

**REVISION JULY 1999**

# Introduction

You have just been issued the Modular Lightweight Load-Bearing Equipment known as MOLLE.

MOLLE is a modular Load-Bearing system designed to enhance the survivability and lethality of the modern Soldier and Marine. MOLLE is a replacement for the current ALICE system and components of the Integrated Individual Fighting System including the Enhanced Tactical Load-Bearing Vest.

Your Central Issue Facility or Supply should issue a complete MOLLE set with the appropriate pockets to match your squad position.

## The MOLLE system

consists of the fighting load vest, the main rucksack, the sleep system carrier, the patrol pack, the frame, sustainment pockets, six foot lashing straps, hydration bladder, repair kit, and additional pockets.

A common **vest** is provided for all Soldiers and Marines with specialized **removable pockets** for Rifleman, Pistol, SAW Gunner, Grenadier and Medic or Corpsman configurations.

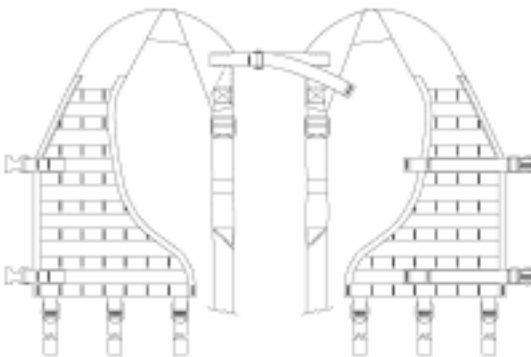

The pockets for each squad position come packed with each vest and ruck.



fig. 1



fig. 2



fig. 3



fig. 4



fig. 5



fig. 6  
fig. 10



fig. 7



fig. 8



fig. 9



### Pockets:

- fig. 1 100 round utility pocket
- fig. 2 200 round magazine pocket
- fig. 3 medical pocket
- fig. 4 30 round single magazine pocket
- fig. 5 30 round double magazine pocket
- fig. 6 single high explosive 40mm grenade pocket
- fig. 7 double high explosive 40mm grenade pocket
- fig. 8 double 40mm illumination round pocket
- fig. 9 9 mm magazine pocket
- fig. 10 fragmentation grenade pocket

Every vest regardless of duty position also comes with a **utility pouch** attached to the belt.

The **rucksack** and **shoulder straps** come pre-assembled to the **frame**. The other components are provided as add ons that can be attached by the individual soldier or marine as needed.

The MOLLE system provides far more load carrying capabilities than the ALICE and other fielded systems. However, proper new equipment training is required in order for the system to be used to

its maximum capabilities. These capabilities are illustrated to assist soldiers and marines with familiarization of the system.

The **vest modularity** allows for commanders to tailor the loads to meet mission needs without unnecessary extra pockets and gear. The vest is designed to reduce heat build up on the back with mini-

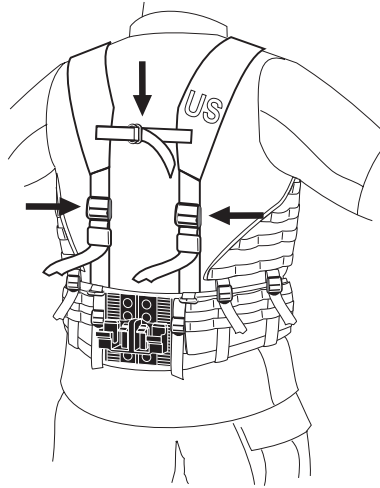

imum area of coverage with the **H-Harness design**.

The **wide shoulder straps** of the vest help distribute the load without the need for excessive padding that can hinder mobility and sighting a weapon.

**To properly attach a pocket**, choose the desired attachment point on the vest panel. Line up the top of the pocket even with the top of the nearest horizontal one-inch webbing that goes across the panels. Insert the pocket attachment strap down the **1 1/2" channel**, then behind the **1" webbing** on the back of the pocket. (See figure on page 4).

Continue weaving the attaching strap behind the horizontal webbing on the vest and the webbing on the back of the pocket until the pocket is secured along its entire length.

This attachment system is extremely secure and stable when used properly.

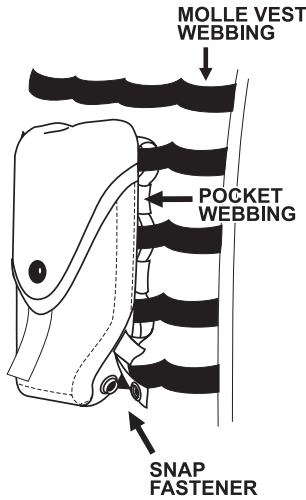

**Do not** simply place the attaching strap through the vest webbing without the interlocking weave. The pockets will not be secure if attached in this manner.

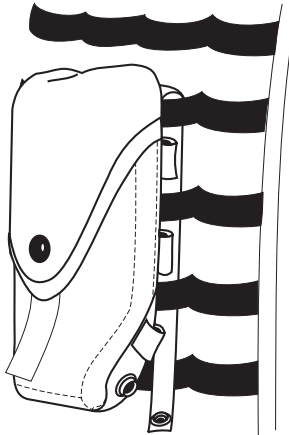

***WRONG WAY***

The **Rifleman configuration** is designed to hold two 30 round magazines in the double pockets and one magazine in the single pockets. Two fragmentation grenade pockets are also worn by the rifleman along with a utility pouch.

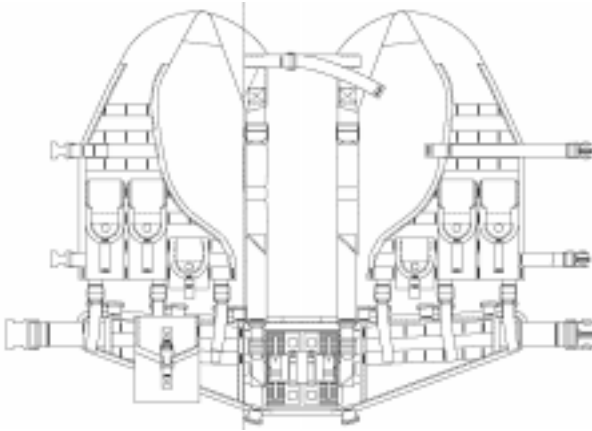

The **Rifleman- Pistol configuration** holds four single 9mm magazine pockets and two fragmentation grenades as shown. In addition to the configuration shown, you will receive two single 30 round magazine pockets and two double 30 round magazine pockets.

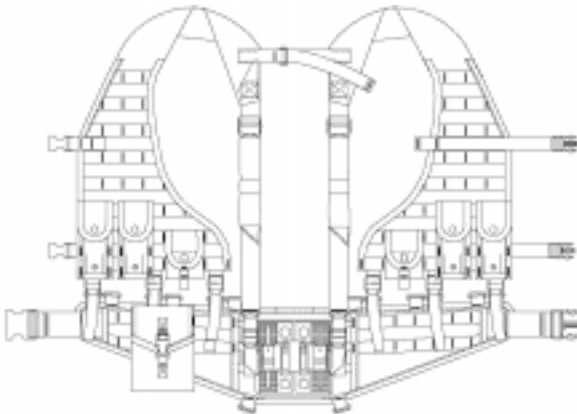



The **Rifleman - SAW Gunner** configuration accommodates two 200 round magazine pockets and three 100 round magazine pockets (one of which is the utility pocket), and two single 30 round magazine pockets as shown. In addition to the configuration shown, you will also receive two double 30 round magazine pockets and two fragmentation grenade pockets. Twelve five-round shotgun pouches are also available to fit mission needs.

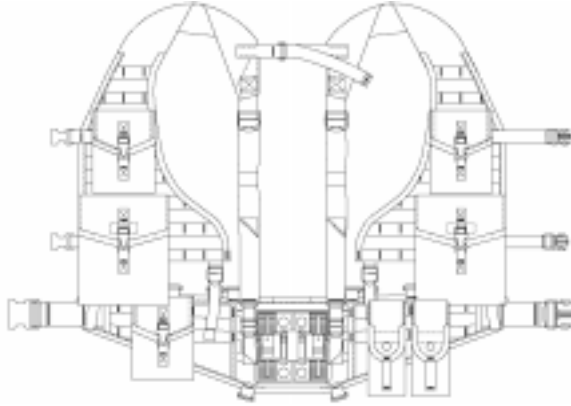

The **Rifleman - Grenadier** configuration consists of fourteen single high explosive grenade pockets and two double illumination round pockets. Also included are two double 30 round magazine pockets and a utility pouch as shown. In addition to the configuration shown, you will receive two single 30 round magazine pockets and two fragmentation grenade pockets.

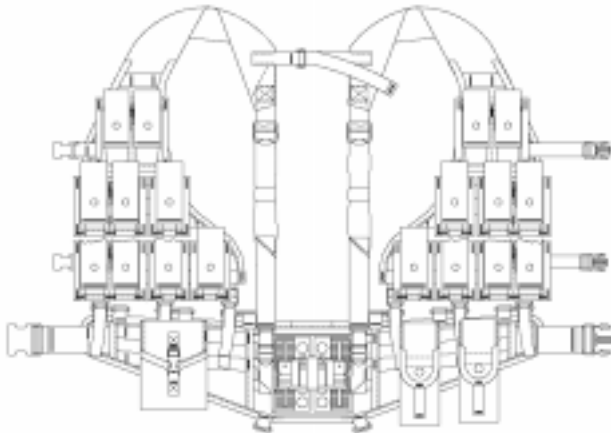

**The Rifleman - Medic configuration** will receive four zippered medical pockets for the vest and two double 30 round magazine pockets as shown below. In addition to the configuration shown, you will also receive two single 30 round magazine pockets and two fragmentation grenade pockets. There will also be a specialized panel loading medical bag that has an additional four removable medical pockets attached to it.

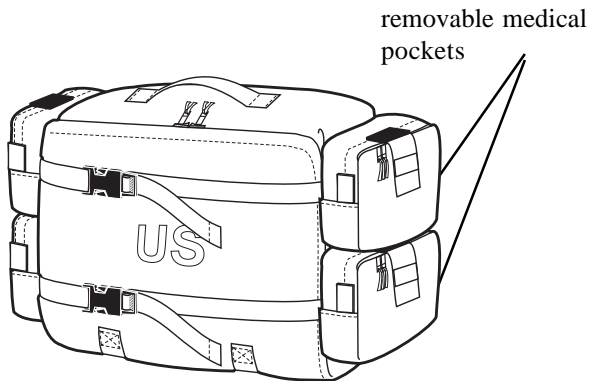
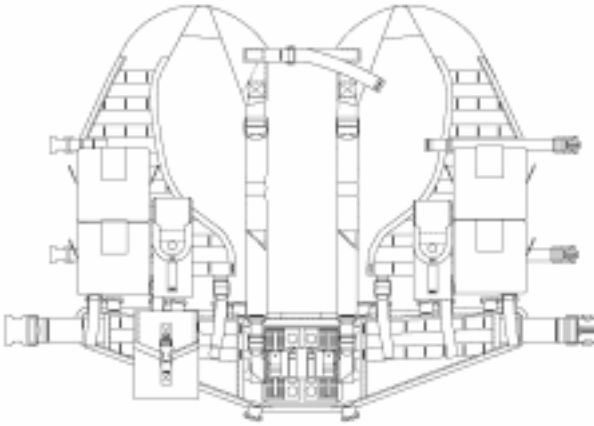

Girth adjustments of the vest are made by lengthening or shortening the two one-inch webbing which forms the front torso closures.

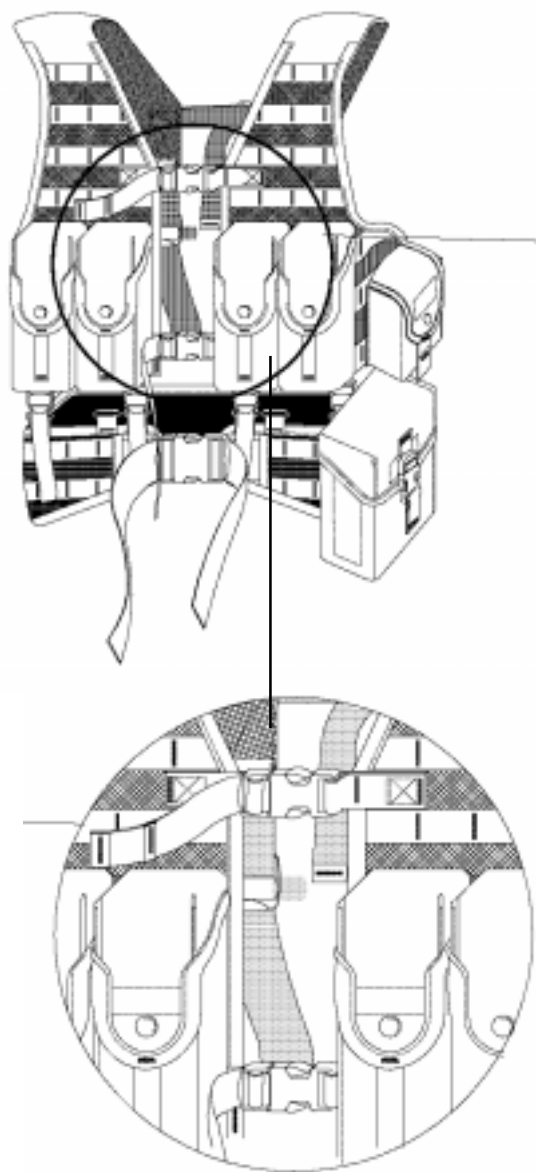

Additional size adjustments are made by extending or shortening the two pieces of 1 1/2 inch webbing on the back of the vest and the ruck.

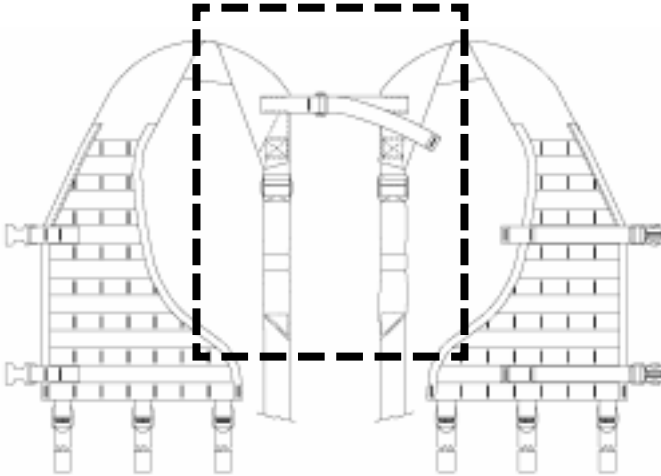

The **ruck attachment straps** are attached at the top slot on the frame with a three bar buckle and webbing. The sides of the ruck are attached to the frame by using the buckles as toggles through the vertical openings. The belt comes in three sizes: small, medium, and large. The small belt fits waists 28" to 35", the medium fits 35" to 40", and the large fits 40" and larger. A properly fit belt should not be able to touch at the ends when fully tightened around the waist, yet the ends should extend beyond the prominence of the hip bone towards the center of the body.

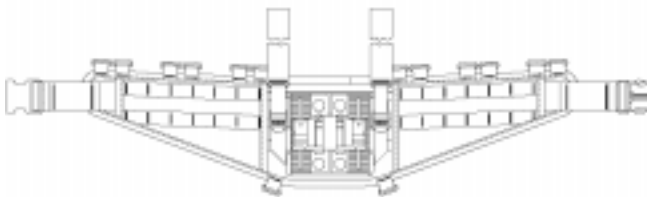

It is important to have a belt that fits properly in order for the system to shift some of the rucksack load off of the shoulders and on to the hips.

The belt is equipped with a removable insert that has a female connector into which the frame joins. The female connection socket can be adjusted up or down to size for torso lengths.

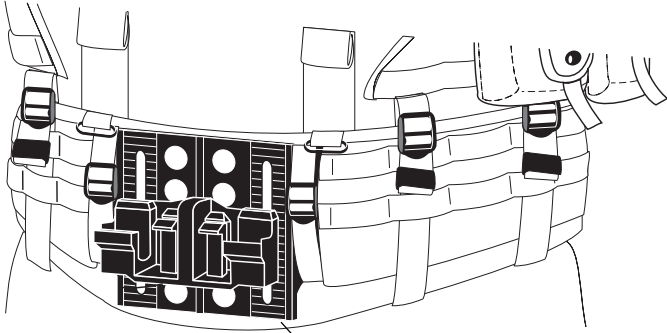

If the ruck needs to be higher or lower on the back, the socket can be moved by loosening the screws that hold the rigid washers in place. Move the socket to the desired location and re-tighten.

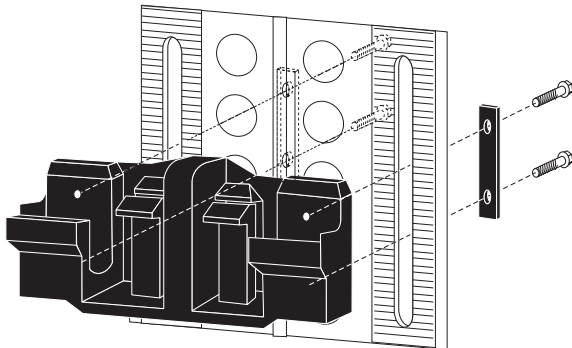
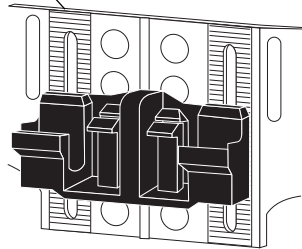

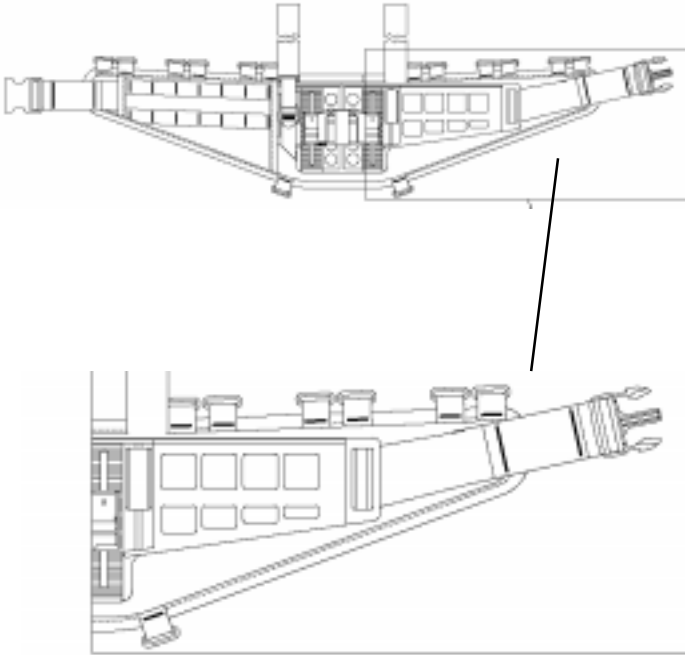

To connect the insert to the padded foam belt, slide the two inch webbing through the belt insert retaining slots on both sides. Then slide the ends into the sleeve of each belt wing and tighten the webbing.

The MOLLE ruck consists of:

## The Main Ruck

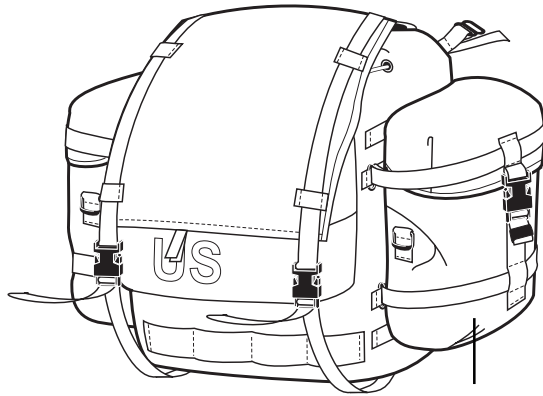

side sustainment  
pockets

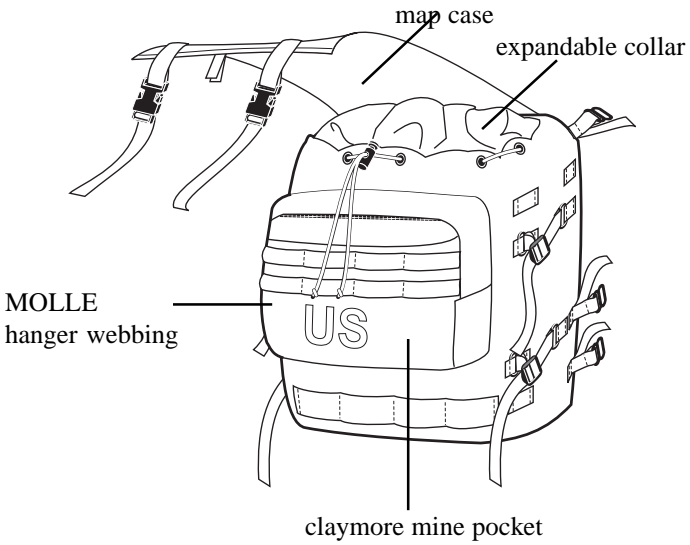

## The Patrol Pack

attachment strap to frame

carrying handle

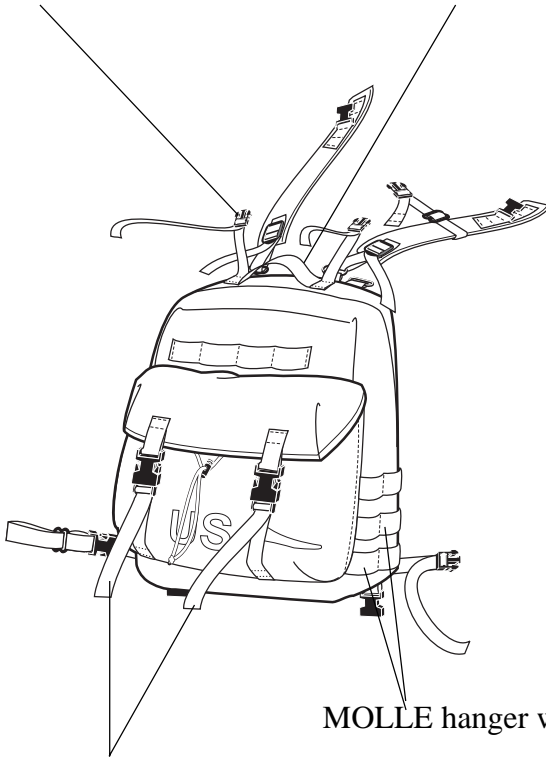

compression straps

MOLLE hanger webbing



## The Sleep System Carrier

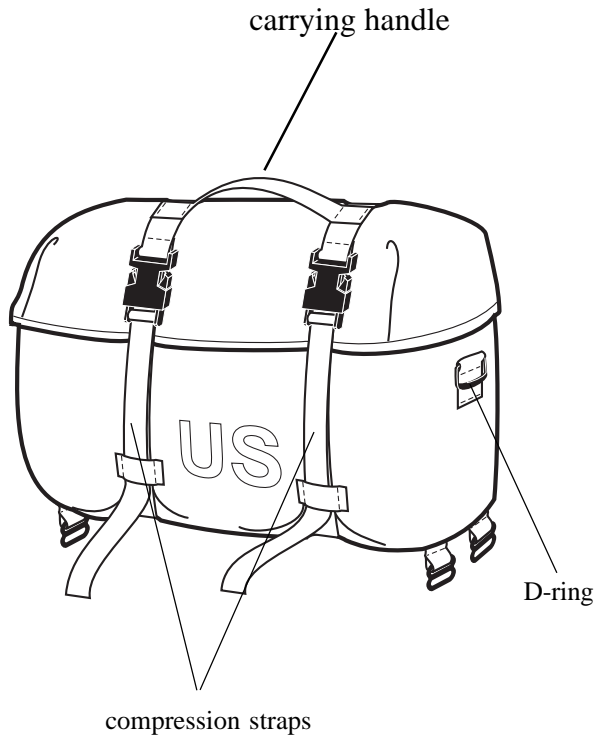

## Frame

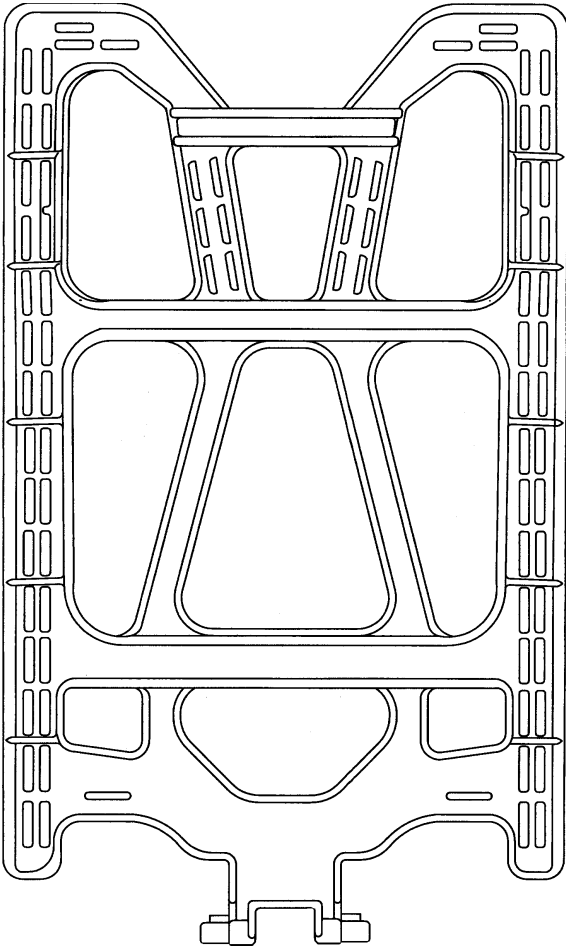

The shoulder strap suspension of the frame is adjusted by securing the one inch webbing around the frame in the appropriate location using the slide buckle. The proper location is determined by inserting the frame in the waist belt insert while wearing the vest and have a buddy position the shoulder straps so contact is made with the top and front of the shoulders. After the one inch webbing is secured around the frame to hold the shoulder straps in place, wrap the two inch webbing around the cross bar and secure with the slide buckle.

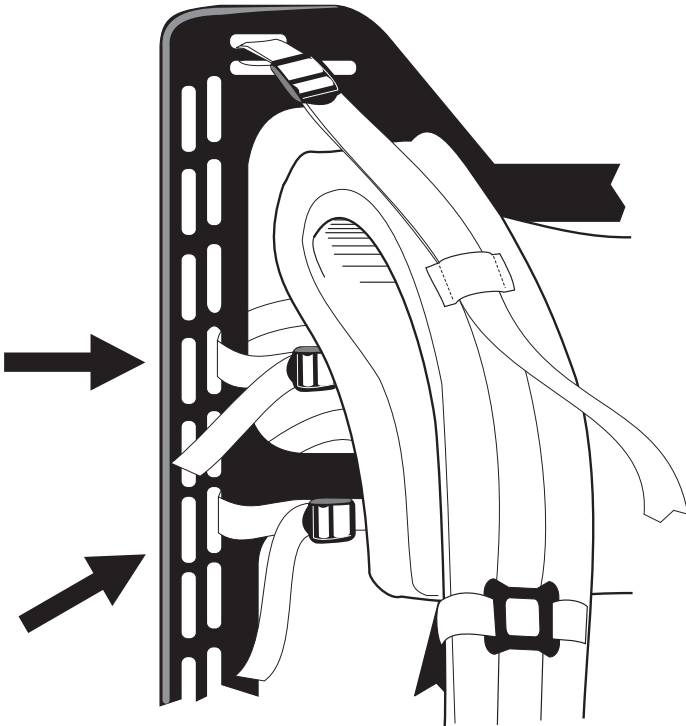

### CAUTION

Proper attachment is **extremely** important to prevent load sway.

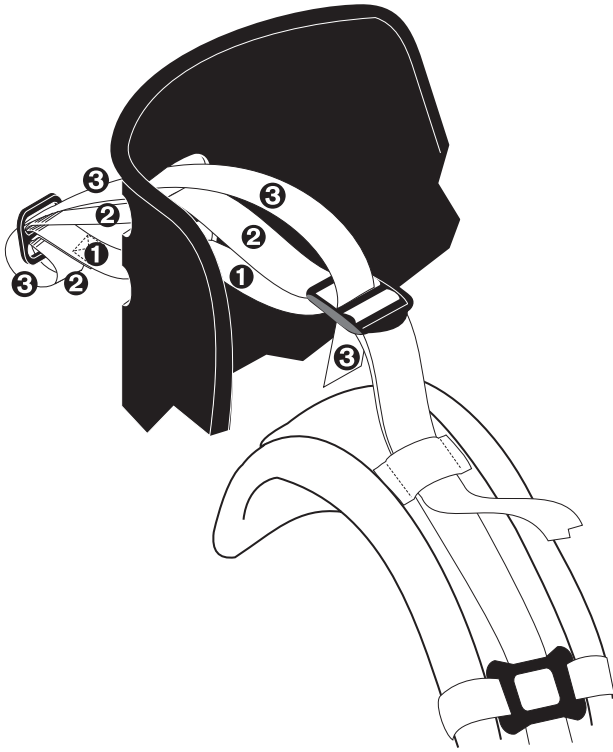

Front stabilizer straps can be used to adjust the pack while marching. The weight of the pack can be transferred from the shoulders to the hips and back again by either cinching the 1" webbing down or by loosening the webbing by adjusting the triglide buckle.

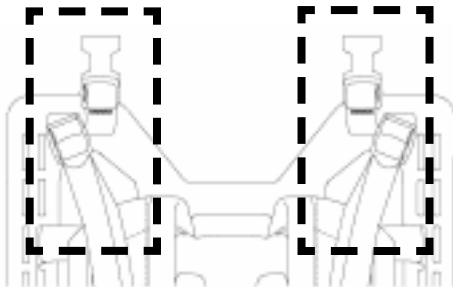

The ruck attachment straps are attached at the top slot on the frame with a three bar buckle and webbing. The sides of the ruck are attached to the frame by using the buckles as toggles through the vertical openings.

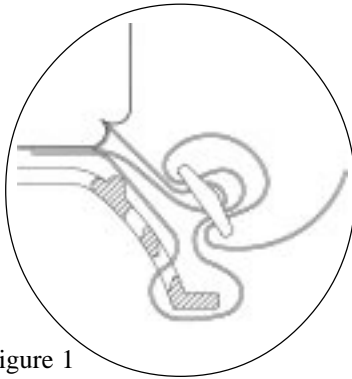
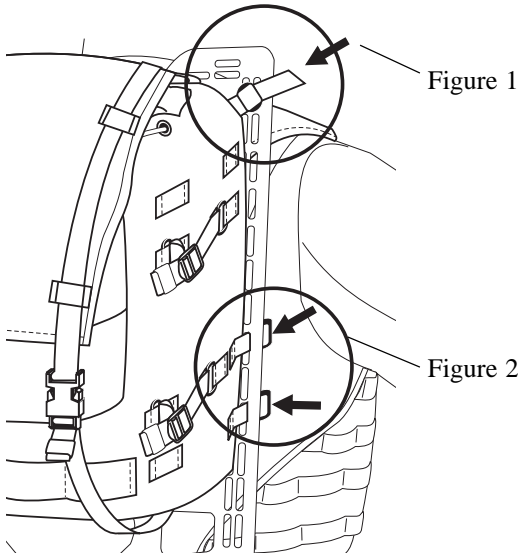

Figure 1

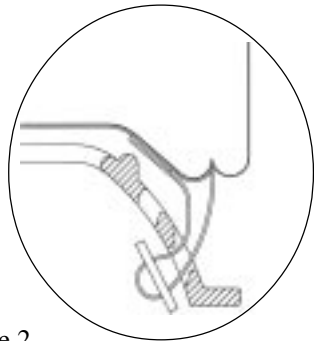
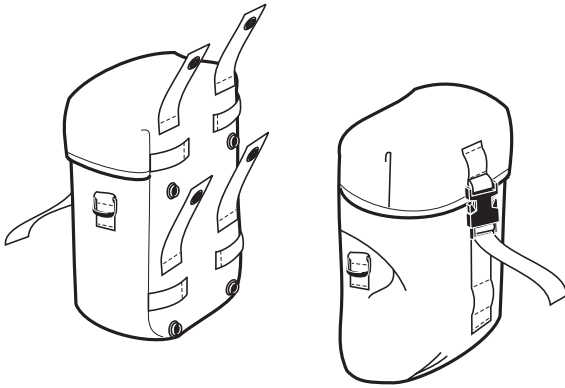

Figure 2

The rucksack has two large, removable sustainment pouches which attach to the side of the rucksack using the same interlocking attachment system as the vest pockets. These sustainment pouches each contain two D-rings on the sides which allow them to be carried by the General Purpose Sling for alternate uses.

The sustainment pockets can also be added to the side of the Patrol Pack to nearly double its capacity. All of the large pockets of the MOLLE system have D-rings on the sides to allow the item to be slung with a GP sling.



The front pocket on the rucksack is designed to accommodate a claymore mine.

The claymore mine pocket also contains a removable bandoleer which holds up to six additional thirty round magazines which can be slung across the shoulders.

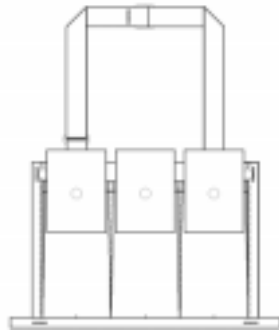

The top flap of the rucksack is a clear removable map case with a hook and loop closure. The clear side can be written on with a grease pencil.

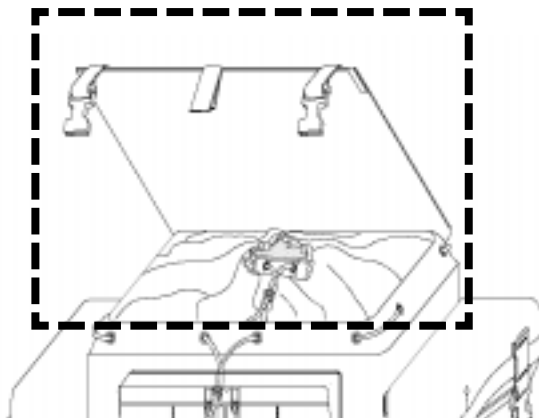

The sleep system carrier is attached directly below the ruck in the same manner. It is sized to accommodate the Modular Sleep System. When the sleep system carrier is secured, the top opening is oriented 180 degrees to the frame for easy access to the flap and opening. The straps which hold the rucksack are inserted through the webbing loops on the sleep system carrier to prevent the sleep system carrier from bouncing.

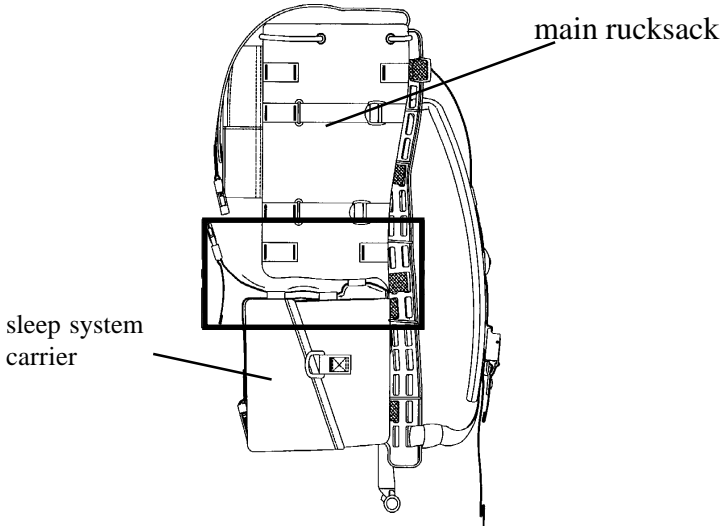

***IF SLEEP SYSTEM CARRIER BOUNCES,  
IT IS NOT ATTACHED PROPERLY***

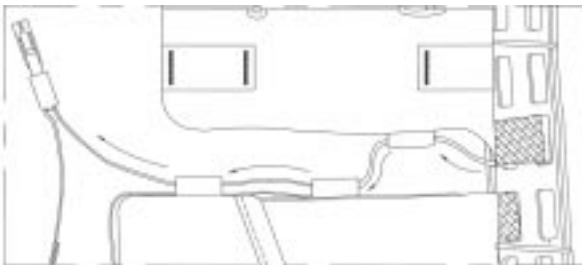



## Radio Operators:

The rucksack contains a collar made of water resistant material which is secured with a cord and barrel lock. Inside the rucksack, against the back panel is a removable radio pocket designed to carry a SINGARS radio.

### Radio Pocket

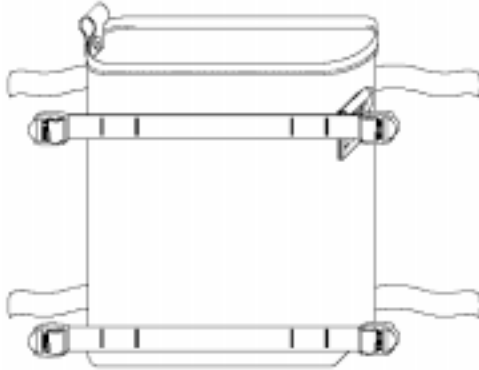

This removable pocket contains D-rings on each side to allow the radio to be carried by the General Purpose Sling when a ruck is not needed. When the radio must be carried in the rucksack the radio pocket is secured to the four black metal loops on the inside of the rucksack using the one inch webbing. The radio can also be carried in with the antenna exiting between the two slides of the zipper.

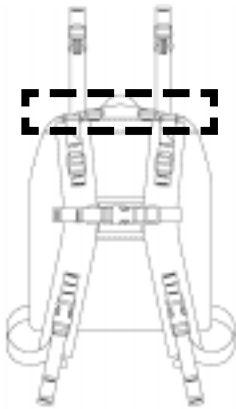

The patrol pack is intended to be worn on top of the load bearing vest. The patrol pack has a volume of approximately 1,200 cubic inches including the outside pocket.

There are black metal loops at the top of the back panel of the patrol pack. These loops are attachment points for the shoulder straps. The two outer loops are to provide better compatibility with bulky armor or clothing, and the inside loops are used for narrower chest and neck circumferences.

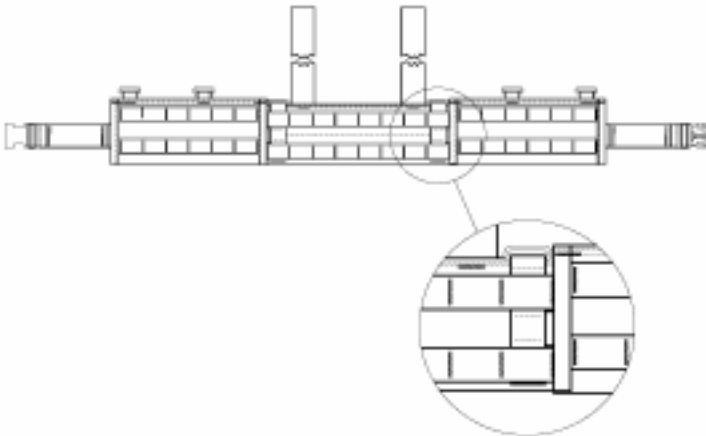

There is a secondary three inch wide belt that comes with every MOLLE system. (See figure this page.) It is intended for those soldiers and marines who prefer to have the large padded waist belt permanently attached to the frame, and a smaller belt for the LBV.

To use this belt, remove the large padded belt from the LBV. Connect the large belt to the frame, using the probe and socket. There are two short pieces of one inch webbing with a friction buckle which secure the belt to the frame in the manner shown. Be sure to fully tighten the webbing so that the belt is secure.

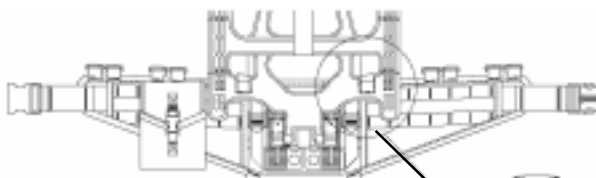

The three-inch wide LBV belt can then be attached to the LBV. This belt is adjustable for size by pulling the stiffened vertical webbing out of the horizontal webbing channels, locating the belt wings to the desired location, and reinserting the stiffened webbing in the appropriate location.

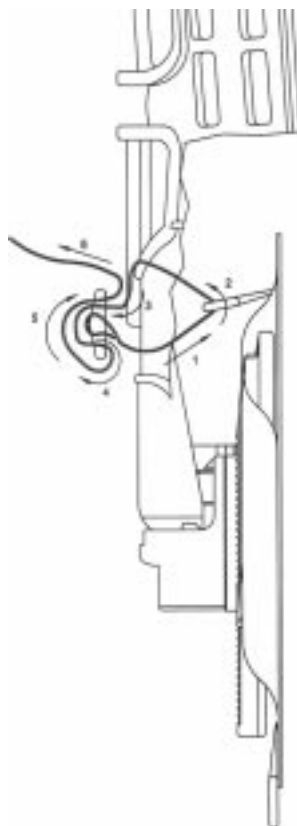

Get to know your MOLLE system and experiment with different load configurations. Get used to removing items that are not needed so the load is as clean and streamlined as possible.

There are several possible load configurations.  
Five common configurations are:

1. The Light Fighting Load which consists of the Load-Bearing Vest and Butt Pack.

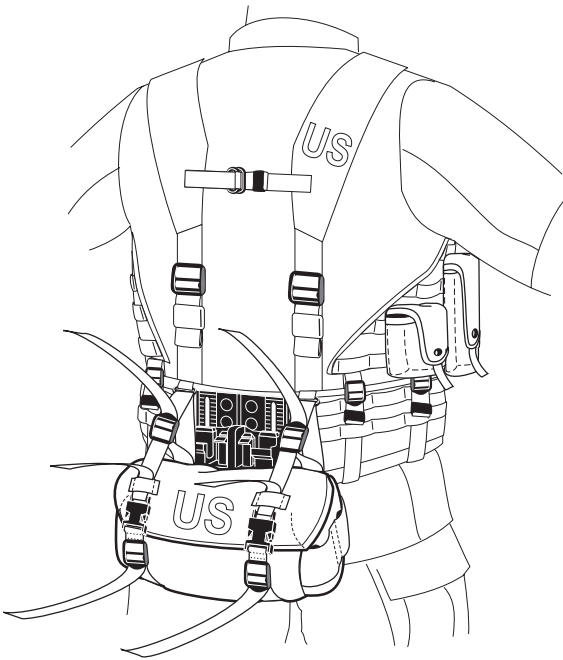

Attach buttpack loosely to make sure socket is exposed when the pack frame will be worn.

2. The Assault Pack Load consists of the Load-Bearing Vest, Butt Pack and Patrol Pack.



3. The Light Rucksack Load consists of the four items from the Assault Pack Load plus the Rucksack and Frame.

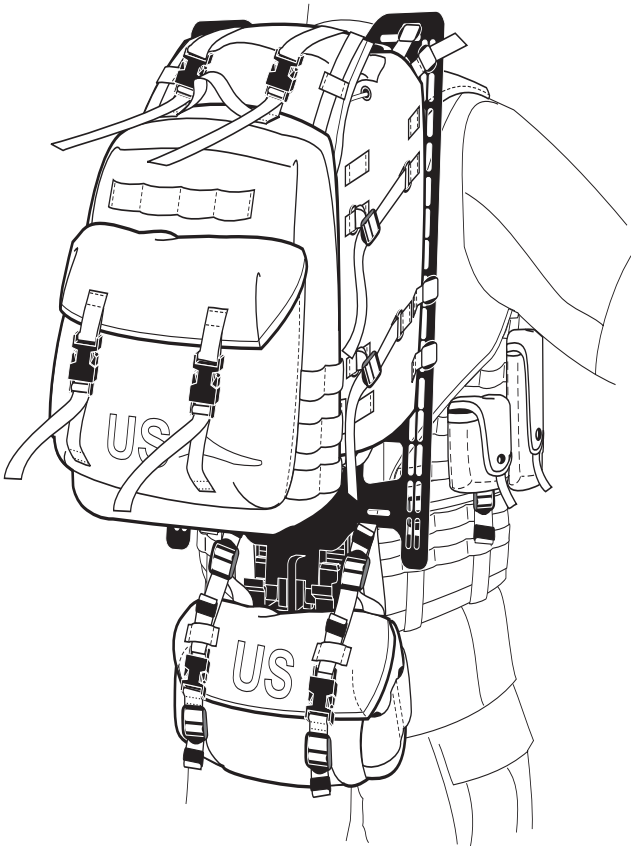

4. The Intermediate Rucksack Load consists of items from the Light Rucksack Load plus the side Sustainment Pockets on the ruck.

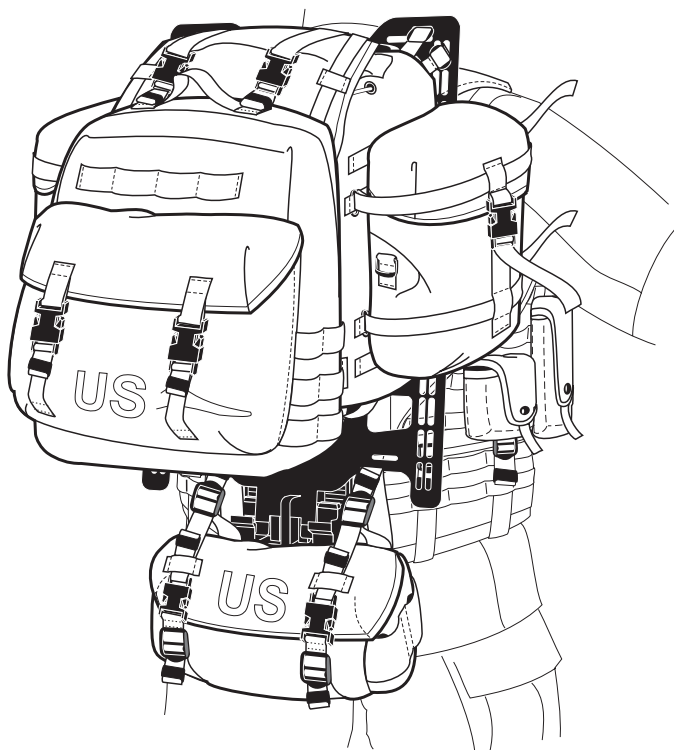

5. The Full Rucksack Load consists of the items from the Intermediate Rucksack Load plus the Sleep System Carrier.

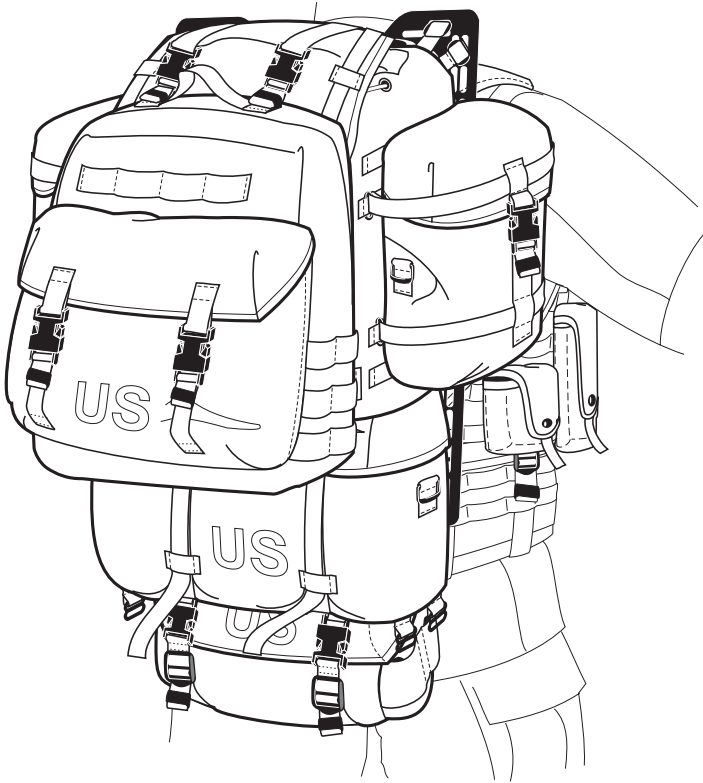



## Donning and Doffing

To properly don the rucksack, the soldier/marine must already be wearing the vest with the belt insert. **ALL LOOSE WEBBING ENDS SHOULD BE TAPED TO AVOID INTERFERENCE WITH THE SOCKET.**

The rucksack is slung on the back, and before the shoulder straps are tightened, the pack frame must be inserted into the waist belt socket and rocked backward slightly to seat it in the socket.

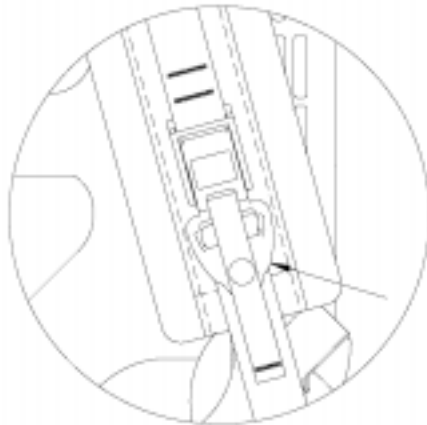

For routine doffing of the ruck, the user can loosen the shoulder straps by pulling upward on the quick-release buckle tab, let the ruck rotate back slightly and ease it off.

Emergency doffing can be accomplished by sharply pulling upward on the quick-release lanyard to disengage the buckle and letting the ruck fall away.



The ruck can also be doffed when in the prone by simply activating one of the shoulder strap quick-releases and letting the ruck fall off by twisting to one side. To re-attach the quick-release buckle, simply insert the male portion into the female portion and push until the latch tab clicks. Do not try to push down on the latch tab.

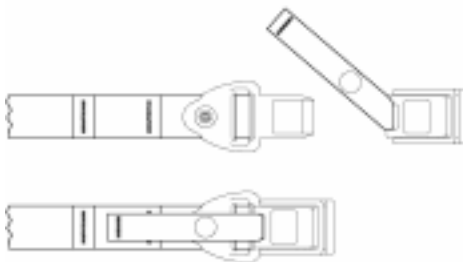

When there is no time to secure the frame probe into the waist belt socket, simply don the ruck with the shoulder straps and move out. When time allows, the soldier or marine can take a few seconds to insert the probe into the socket.

## Cleaning and Maintenance

Scrape dirt and dust from the item using a brush that will not cut into the fabric.

Hose or wash the item in a pail of water using mild detergent or soap.

Rinse thoroughly with clean water.

**Do not use chlorine bleach, yellow soap, cleaning fluids, or solvents that will discolor or deteriorate the item.**

Dry the item in shade or indoors. Do not dry in direct sunlight, direct heat or open flame.

Do not launder or dry item in fixed commercial home type laundry equipment.

Do not attempt to dye or repair.

Turn in for repair or replacement.

**Remember, extremely dirty or damaged equipment can eventually fail to perform its intended function.**

**Our mission is to provide Soldiers and Marines with the best combat equipment possible.**



We are interested in hearing from you regarding MOLLE. If you have any questions or comments which can enhance the MOLLE system, please feel free to contact the SBCCOM MOLLE team at DSN 256-5453, commercial 508-233-5453, or email [jkirk@natick-emh2.army.mil](mailto:jkirk@natick-emh2.army.mil)



If you have any comments concerning any other SBCCOM commodities, such as Clothing, Individual Equipment, Food, Shelters, or Airdrop Items, call our **hotline** at DSN 256-5341 or commercial 508-233-5341.

## MOLLE COMPONENTS

Description	NSN Number
MOLLE, Rifleman, Complete pack Set	8465-01-459-6572
MOLLE, SAW Gunner, Component Set	8465-01-459-6580
MOLLE, Grenadier, Component Set	8465-01-459-6582
MOLLE, Pistolman Component Set	8465-01-459-6584
MOLLE, Combat Medic Component Set	8465-01-459-6585
MOLLE, Waistbelt, Molded, Small	8465-01-465-2109
MOLLE, Waistbelt, Molded, Medium	8465-01-465-2110
MOLLE, Waistbelt, Molded, Large	8465-01-465-2111
MOLLE, Bladder, Hydration	8465-01-465-2096
MOLLE, Pouch, Grenade, Hand	8465-01-465-2093
MOLLE, Pouch, Magazine, M16A2, Double (30 rounds)	8465-01-465-2092
MOLLE, Pack, Patrol	8465-01-465-2088
MOLLE, Belt, Utility	8465-01-465-2082
MOLLE, Adapter, ALICE Clip	8465-01-465-2062
MOLLE,Pouch, Magazine, M16A2, Single (30 rounds)	8465-01-465-2079
MOLLE, Pouch, Utility	8465-01-465-2070
MOLLE, Set, Buckles	8465-01-465-2080
MOLLE, Pack, Butt	8465-01-465-2058

## MOLLE COMPONENTS

Description	NSN Number
MOLLE, Pouch, Radio	8465-01-465-2057
MOLLE, Straps, Lashing	8465-01-465-2095
MOLLE, Vest, Load Bearing (LBV)	8465-01-465-2056
MOLLE, Pack, Frame	8465-01-465-2158
MOLLE, Carrier, Sleep System	8465-01-465-2124
MOLLE, Carrier, Hydration	8465-01-465-2131
MOLLE, Pouch, Sustainment	8465-01-465-2152
MOLLE, Straps, Shoulders, Frame	8465-01-465-2133
MOLLE, Pouch, 6 Magazines, Bandoleer, M16A2	8465-01-465-2144
MOLLE, System, Hydration	8465-01-465-2154
MOLLE, Pack, Main	8465-01-465-2289
MOLLE, Pouch, 9mm Magazine (single)	8465-01-465-2155
MOLLE, Pouch, 200 Round SAW Gunner	8465-01-465-2263
MOLLE, Adapter, K-Bar	8465-01-465-2272
MOLLE, 40mm High Pyrotechnic Double	8465-01-465-4445
MOLLE, 40mm High Explosive Double	8465-01-465-4417
MOLLE, 40mm High Explosive Single	8465-01-465-4416

## NOTES

The manufacturer of the MOLLE System is

**Specialty Defense Systems**

Dunmore, Pennsylvania

To procure components directly from the  
manufacturer, contact

**Specialty Defense Systems**

570-961-2042



*www.specialtydefense.com*

*email: spp@epix.net*